

# Generate a groundplane

## From IBF-Wiki

This article is part of an introduction tutorial called CrashCourse2

Download this article as PDF-File

A groundplane having the same dimensions like the layout can easily be created by the use of the groundplane assistant, please see layoutmenu "**Actions**":

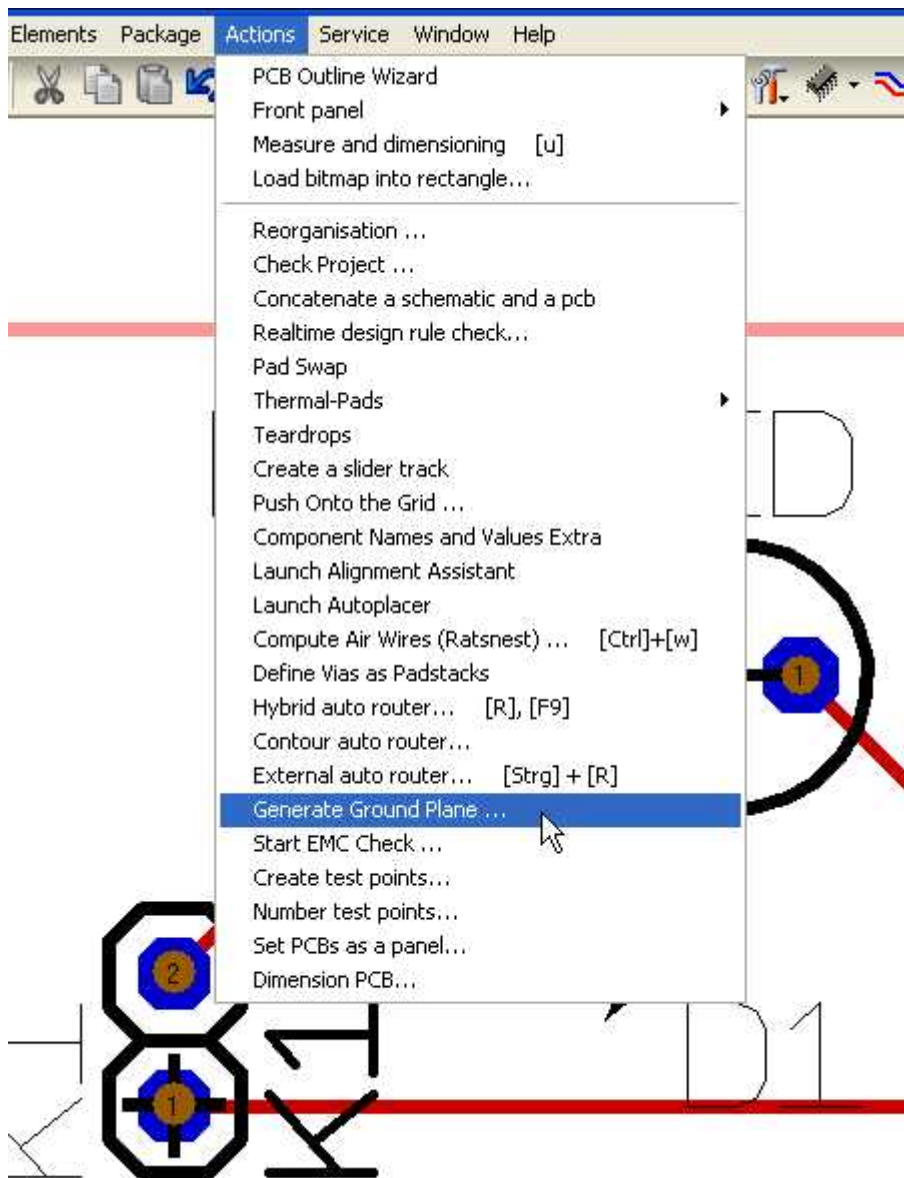

The opening dialog explains that a groundplane in TARGET 3001! is made out of a set of three layers: "copper", "area" and "deletion". The shape of the groundplane is defined on the "area" layer. The "deletion" layer defines the spacings between the groundplane and the non GND-Leading tracks. The layer "copper" at least is the one which carries the groundplane and the tracks in copper. The following example is a Groundplane on "copper bottom":

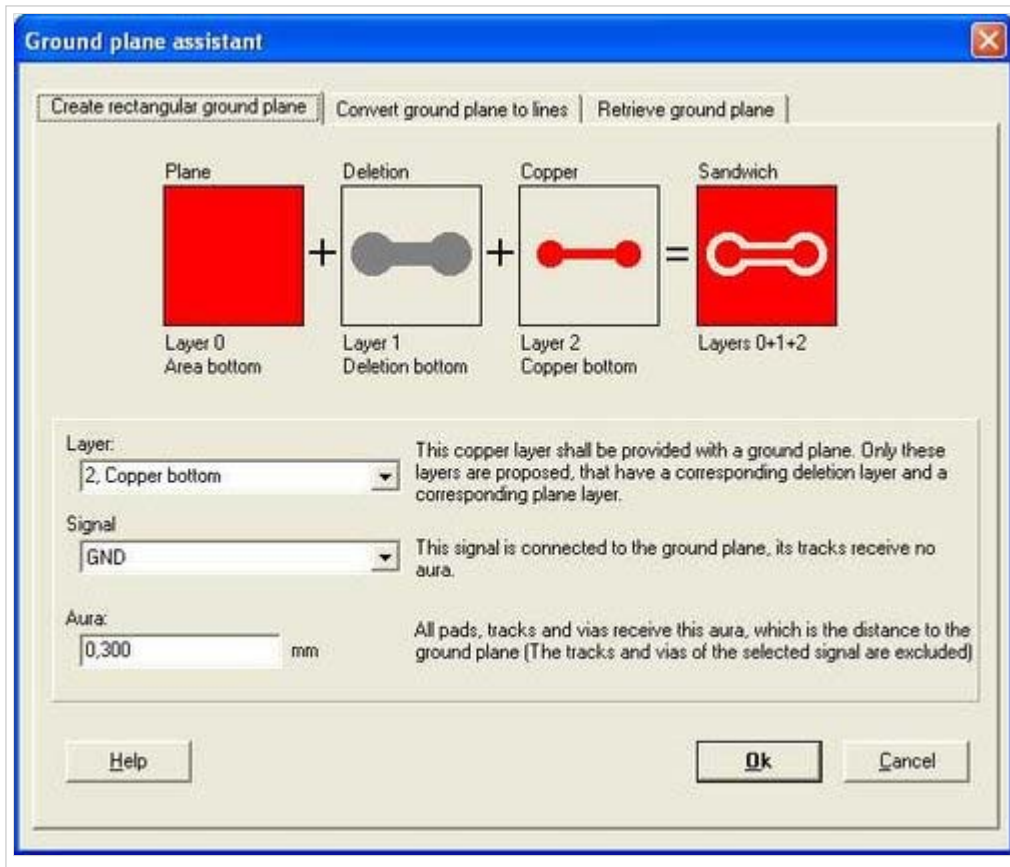

Please confirm the Standard settings and reach the following:

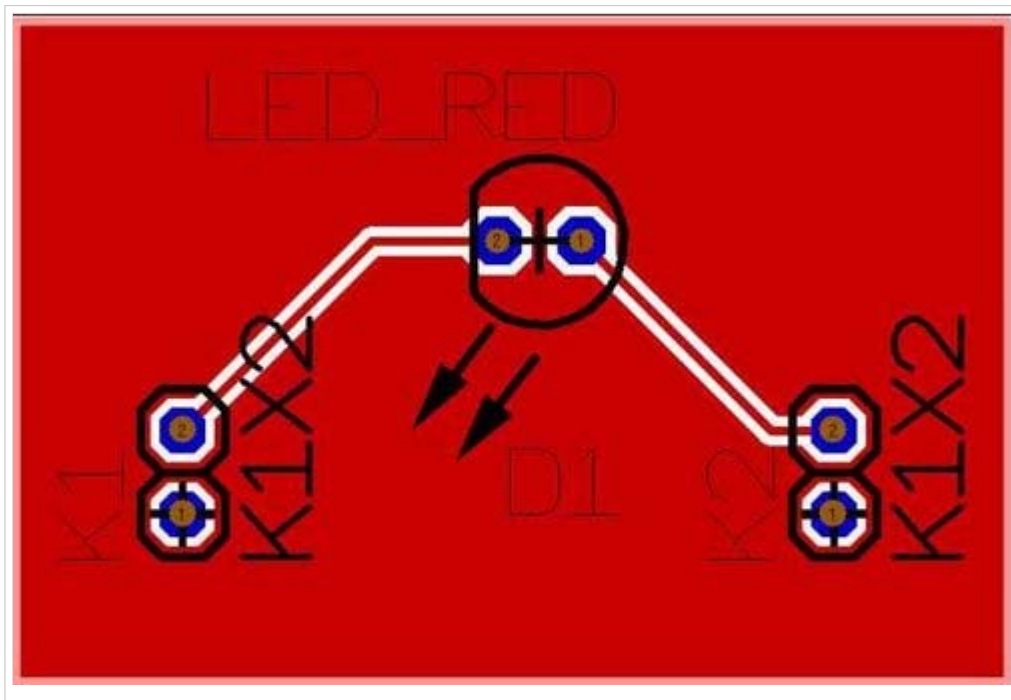

The GND leading track in the south of the layout is embedded completely into the groundplane. Use the hash key (#) for having an x-ray view of the layout. So you can see...

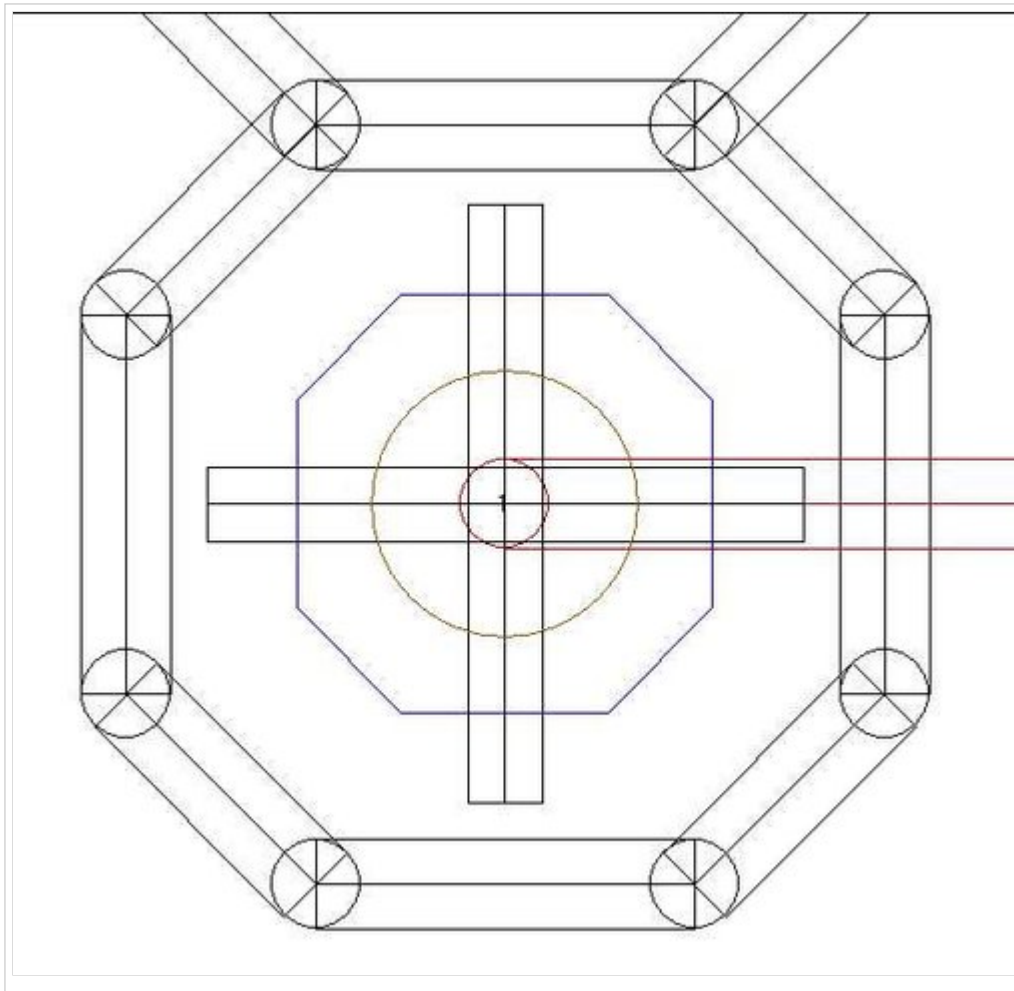

...that the pads are connected correctly.

The generation of thermal pads is managed by highlighting the complete layout and choose menu "Actions/Thermal-Pads". Pads whose signal tracks are embedded to the groundplane, receive three more ligaments. Result:

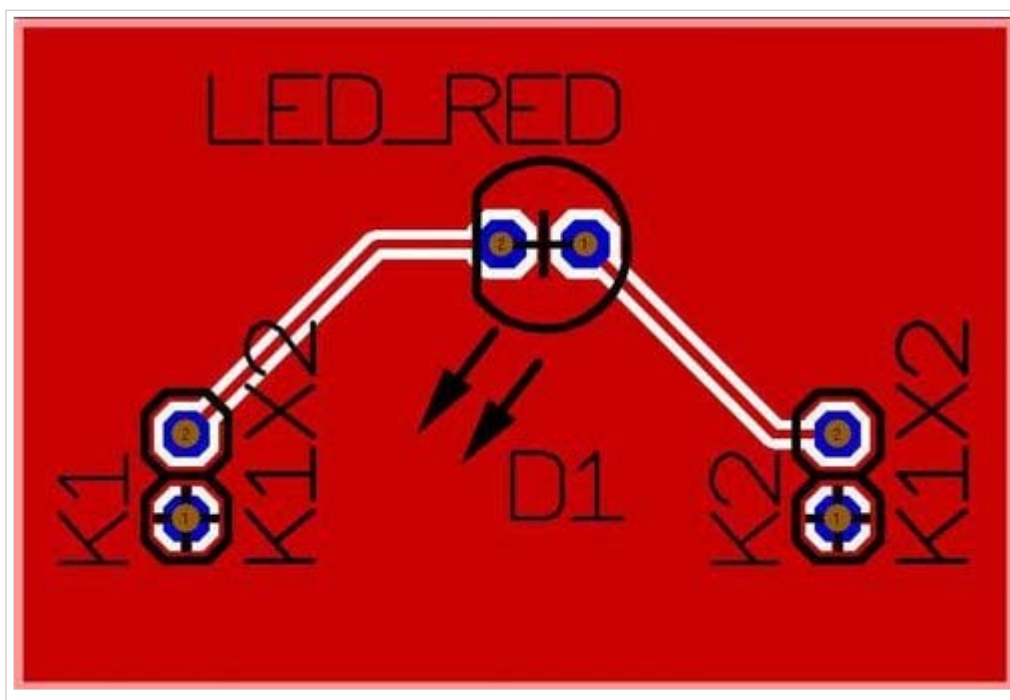

The groundplane can also be transferred to a grid. Please again open the groundplane assistant (menu "Actions/Groundplane assistant") and choose the tab in the middle:

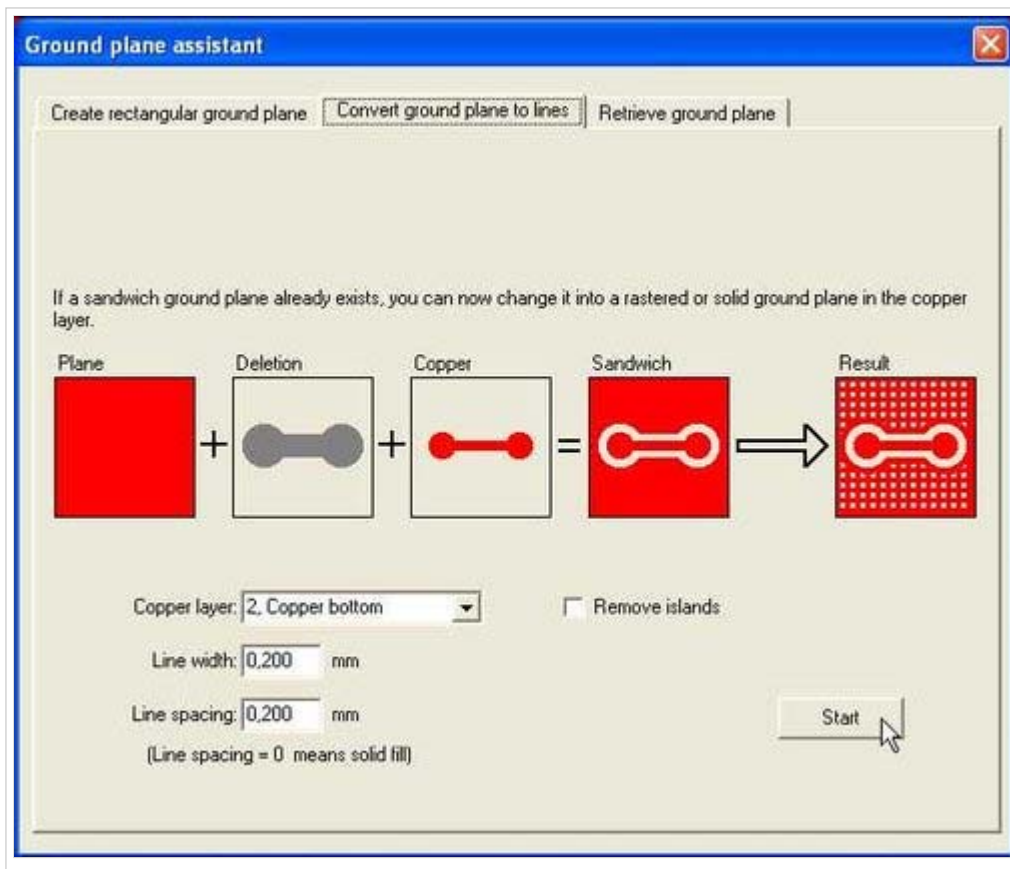

After pressing the "Start"-button, we receive:

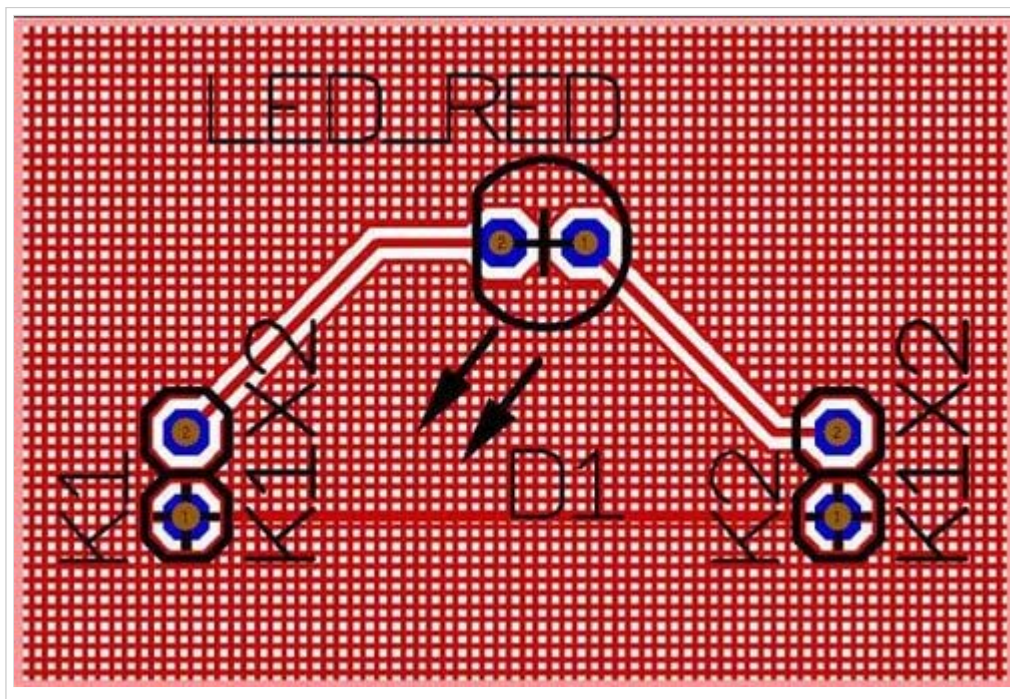

Next step

One step back

Back to the overview

Retrieved from "[http://server.ibfriedrich.com/wiki/ibfwikien/index.php?title=Generate\\_a\\_groundplane](http://server.ibfriedrich.com/wiki/ibfwikien/index.php?title=Generate_a_groundplane)"

Categories: Actions | Automatic functions

**IBF-Intern:**

- This page was last modified 13:54, 15 January 2009.
- This page has been accessed 4,040 times.